

5-5. SEMICONDUCTORS

BA05T

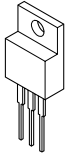

LA6500FA

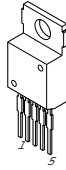

M62392FP

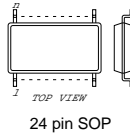

24 pin SOP

PST600C-T

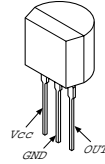

VCC
GND
OUT

TK75003D

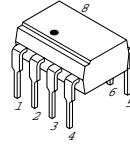

BA10324AF-E2
SN74HC02ANS
SN74HC02ANS-E20
XRA10324AF

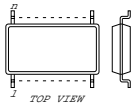

14 pin SOP

LA7840L

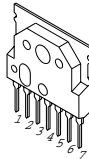

NJM4558M
UPC4558G2

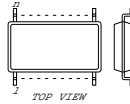

8 pin SOP

STK392-910A

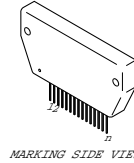

MARKING SIDE VIEW

UPC1093J-1-T

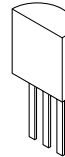

CXA8070P

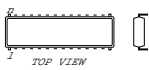

18 pin DIP

LSC4514P2

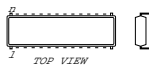

16 pin DIP

NJM78L09UA
TA78L09F-TE12L



ST72751N9B1/LAM

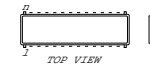

56 pin DIP

UPC5021-109

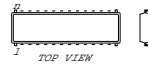

24 pin DIP

CXA8071AP

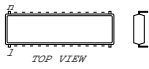

30 pin DIP

LM2405T-C

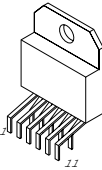

NJM7912FA

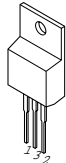

TC7SET08F

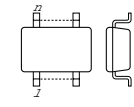

5 pin CHIP

BU2522AX

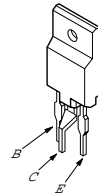

CXA8075S

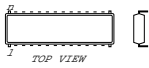

22 pin DIP

MC74HC4053F
TC74HC4053AF

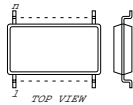

16 pin SOP

PQ12RF11

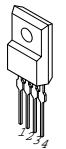

TDA2009A

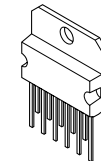

DTA114TK
DTA124EKA-T146
DTA144EKA-T146
DTC314TKH04
DTC314TK-T-146
PDTA124EK-115
PDTA124EK-115
UN2115-QRS
2SA1037AK-T146-QR
2SA1037AK-T146-R
2SA1037K-T-146-QR
2SA1162G
2SB709A-QRS-TX
2SC1623-L5L6
2SC2412K-T-146-Q
2SC2412K-T-146-QR
2SC3735-L-B35
2SC3735-T1B-B35
2SD601A-Q
2SD601A-QRS-TX

CXD8770Q

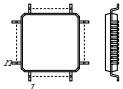

32 pin QFP

MM1382

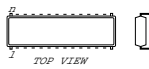

28 pin DIP

PQ6RD83B

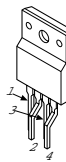

TDA6103Q/N3,112

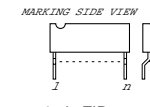

9 pin ZIP

DM-58

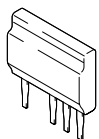

M24C08-BN6

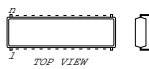

8 pin DIP

TDA7315D013TR

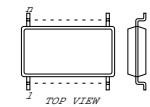

20 pin SOP



IRFI9630GS
IRFI9630GS-LF

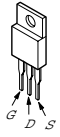

2SA1175-HFE
2SA1309A-QRSTA
2SC2785-HFE
2SC3311A-QRSTA

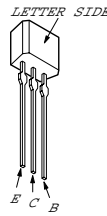

2SJ175
2SJ175-02

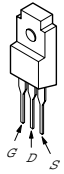

D5S4M

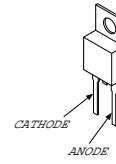

PC123F2
PC123FY2

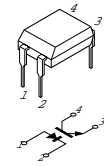

IRFU110
IRFU110A

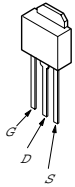

2SK2194F08

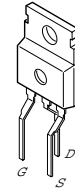

EGP10D
R2KS

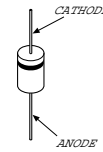

RD6.2M-BT

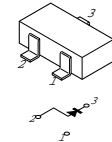

2SB798-DL
2SB798-DLDK

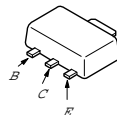

IRLI530GLF33

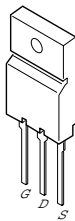

DTZ10B
DTZ33B
MA111
RD12SB2
RD5.6S-B
RD5.6SB3
UDZ-TE-17-10B
UDZ-TE-17-12B
UDZ-TE-17-22B
UDZ-TE-17-33B
UDZ-TE-17-5.6B
UDZ-TE-17-6.2B

2SC2611

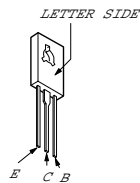

EGP10GPKG23
MTZJ-T-77-18
RB441Q
RB441QT-77
RD10ES-B2
RD12ES-B2
RD18ES-B2
RD27ES-B2
RD4.7ES-B2
RD5.1ES-B2
RD5.6ES-B2
RD6.2ES-B2
1SS119-25

SB340L-5009

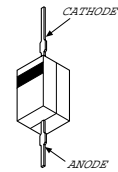

IRLI540GLF33

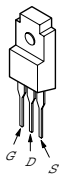

2SC3209LK

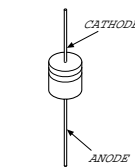
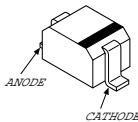
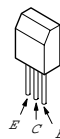

1SS226

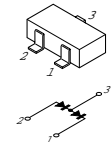

MX0541B-F

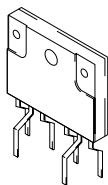

2SC5022-02
2SD2012

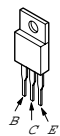

D1NL20
D1NL20-TR2
ERB91-02
HSS82
RGP02-17EL-6433
RGP02-17PKG23
3DL41A

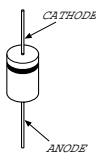

FML-S16S
FMG-G2CS

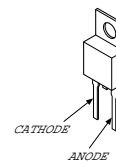

SEL1922D-C
SEL1922D-C,D

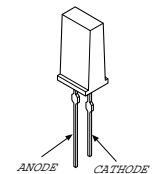

2SA1091-O
2SA1091O-TPE2
2SC3941A-Q

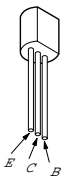

2SK2101-01MR-F141

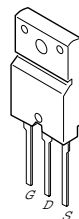

D1NL40
D4SBS4
D4SBS4-F
D4SB60L

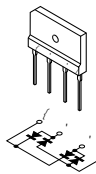

FMQ-G5FMS
5TUZ52C

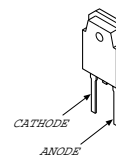

SPB-26MVWF

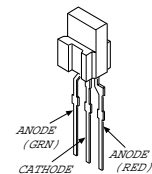

SECTION 6
EXPLODED VIEWS

NOTE:

- Items with no part number and no description are not stocked because they are seldom required for routine service.
- The construction parts of an assembled part are indicated with a collation number in the remark column.
- Items marked " * " are not stocked since they are seldom required for routine service. Some delay should be anticipated when ordering these items.

The components identified by shading and mark Δ are critical for safety. Replace only with part number specified.

Les composants identifiés par un trané et une marque Δ sont critiques pour la sécurité. Ne les remplacer que par une pièce portant le numéro spécifié.

6-1. CHASSIS

- 7-685-648-79 +BVTP 3X12
- 7-685-663-71 +BVTP 4X16
- 7-685-646-79 +BVTP 3X8
- Δ 7-685-881-09 +BVTT 4X8

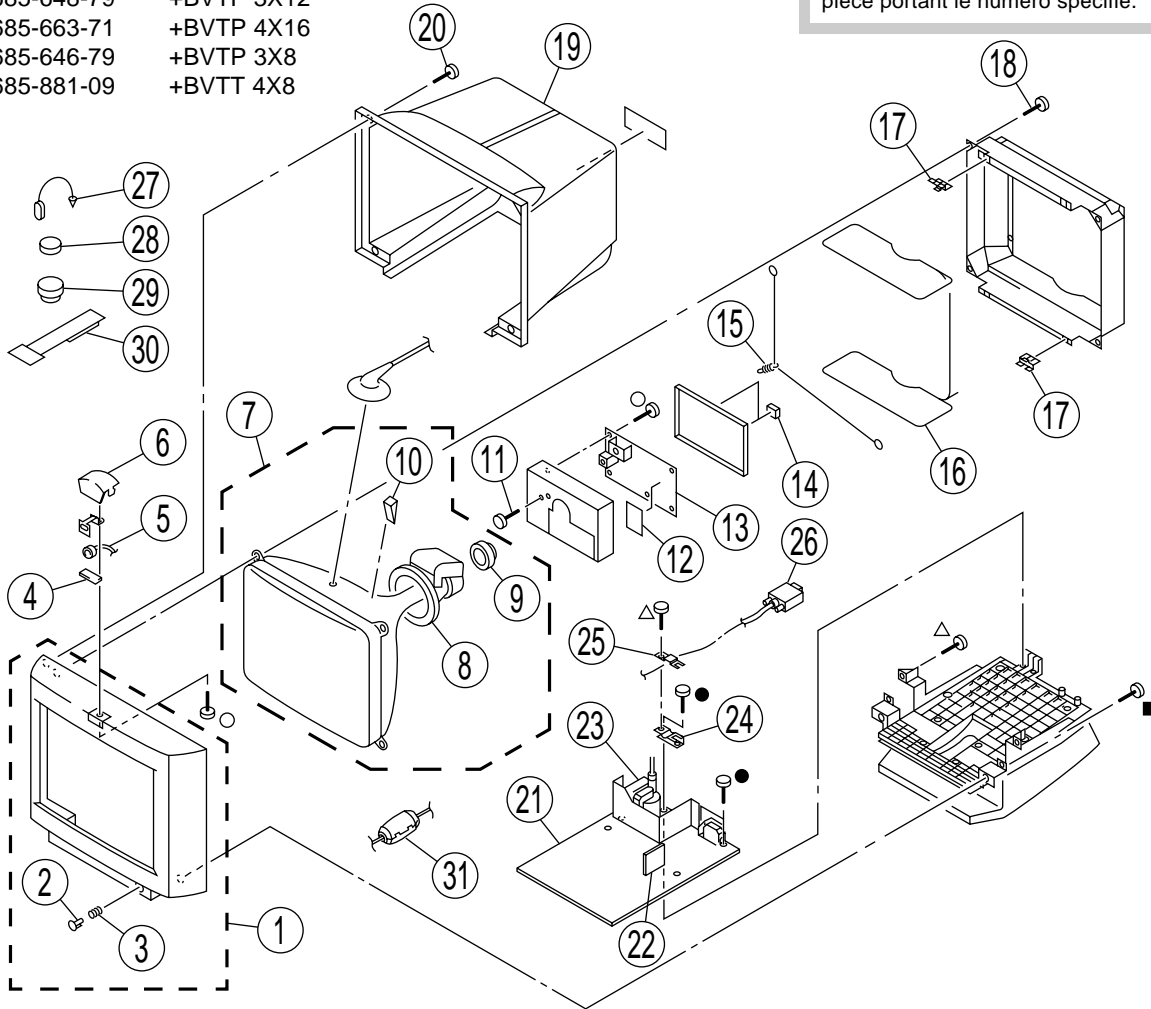

REF.NO.	PART NO.	DESCRIPTION	REMARK	REF.NO.	PART NO.	DESCRIPTION	REMARK
1	X-4035-980-1	BEZEL ASSY	2,3	18	4-365-808-01	SCREW (5), TAPPING	
2	4-066-423-01	BUTTON, POWER		19	4-066-420-01	CABINET	
3	3-653-339-01	SPRING, COMPRESSION		20	4-052-070-11	SCREW +BVTP 4X16	
4	* 4-058-939-01	CUSHION, MICROPHONE		21	* A-1346-765-A	D BOARD, COMPLETE	22
5	1-542-361-11	MICROPHONE ASSY		22	* 8-933-240-00	DA BOARD, COMPLETE	
6	4-058-386-01	CABINET, MICROPHONE		23	Δ X-4036-234-1	TRANSFORMER ASSY, FLYBACK (NX-4402/J1K4)	
7	Δ 8-738-733-83	ITC ASSY (17FRFM-R3)	8-10	24	* 4-045-130-01	BRACKET, CABLE	
8	Δ 8-451-490-11	DEFLECTION YOKE (Y17FRJ3-M)		25	* 4-054-667-01	STOPPER, CABLE	
9	Δ 1-452-912-11	NECK ASSY, PICTURE TUBE (NA-2914)		26	1-783-935-11	CABLE ASSY(15PD-SUB CONNECTOR)	
10	4-050-492-01	SPACER, DY		27	4-308-870-00	CLIP, LEAD WIRE	
11	4-382-854-01	SCREW (M3X8), P, SW (+)		28	1-452-032-00	MAGNET, DISC ; 10mm ϕ	
12	* 8-933-326-00	AA BOARD, COMPLETE		29	1-452-094-00	MAGNET, ROTATABLE DISK ; 15mm ϕ	
13	* A-1294-314-A	A BOARD, COMPLETE		30	4-059-492-01	PERMALLOY (75), CONV.CORRECT	
14	* 4-050-329-01	CUSHION (A)		31	1-500-386-11	FILTER, CLAMP (FERRITE CORE)	
15	* 4-047-316-01	SPRING, TENSION					
16	Δ 1-416-282-11	COIL, DEMAGNETIC					
17	* 4-056-260-01	SPACER, DEGAUSSER COIL					

6-2. STAND BLOCK

- 7-685-648-79 +BVTP 3X12
- 7-685-663-71 +BVTP 4X16

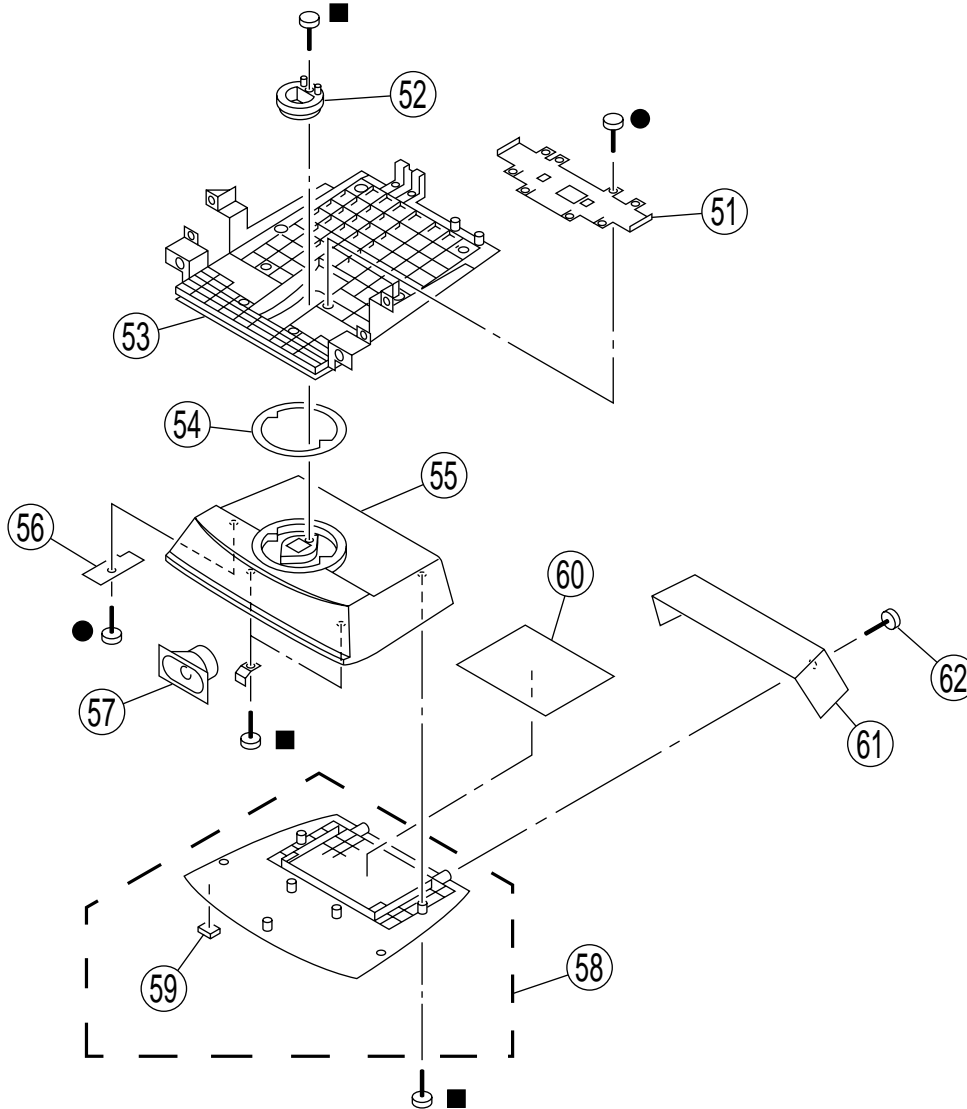

REF.NO.	PART NO.	DESCRIPTION	REMARK	REF.NO.	PART NO.	DESCRIPTION	REMARK
51	*4-058-388-01	COVER, CABLE		57	1-529-123-11	SPEAKER (5X9CM)	
52	*4-058-385-01	STOPPER		58	X-4035-821-1	BASE (LOWER) ASSY, STAND	59
53	4-066-421-01	COVER, BOTTOM		59	*4-061-996-01	CUSHION	
54	*4-041-625-01	RING, TILT SWIVEL		60	*A-1373-698-A	U BOARD, COMPLETE	
55	X-4035-870-1	BASE (UPPER) ASSY, STAND		61	4-065-203-02	BASE (REAR), STAND	
56	*1-669-820-11	J BOARD		62	4-052-070-11	SCREW +BVTP 4X16	

6-3. PACKING MATERIALS

The components identified by shading and mark Δ are critical for safety. Replace only with part number specified.

Les composants identifiés par un tramé et une marque Δ sont critiques pour la sécurité. Ne les remplacer que par une pièce portant le numéro spécifié.

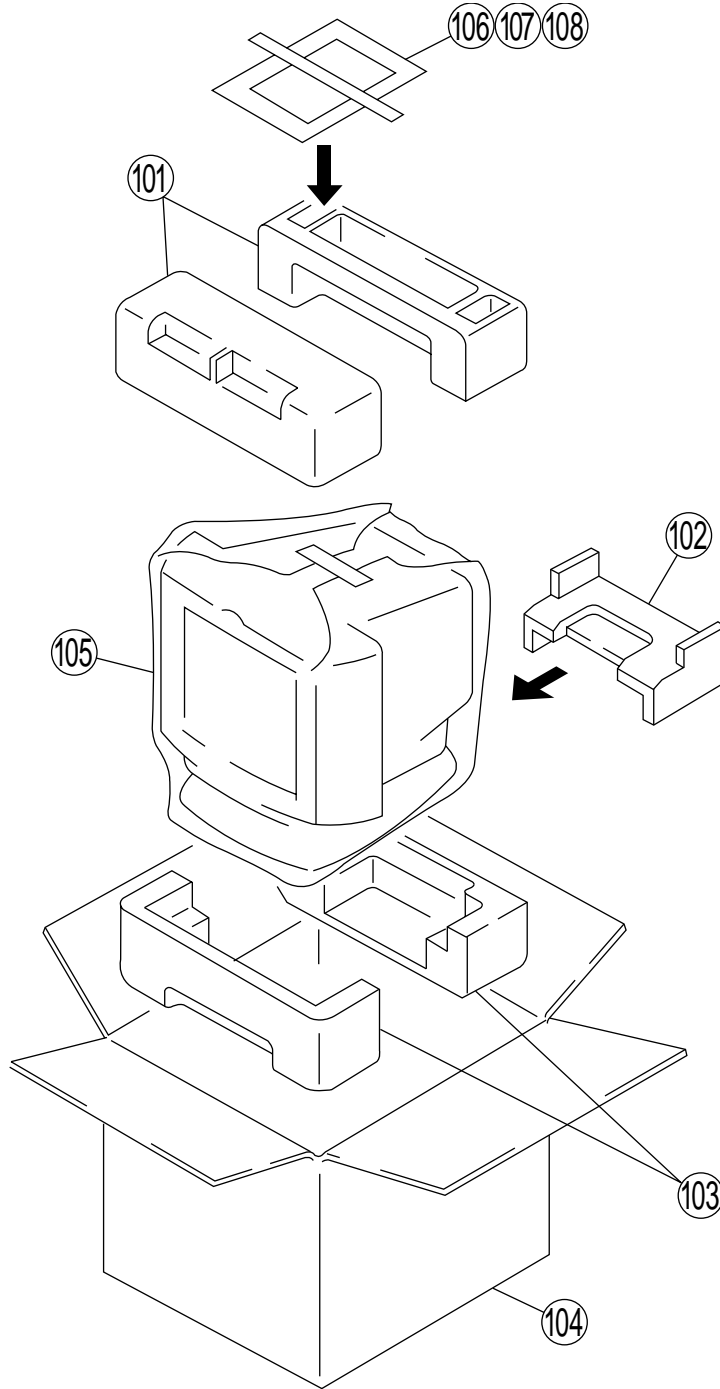

REF.NO.	PART NO.	DESCRIPTION	REMARK	REF.NO.	PART NO.	DESCRIPTION	REMARK
101	* 4-065-435-01	CUSHION (UPPER) (ASSY)		106	Δ 1-534-827-14	CORD SET, POWER	
102	* 4-065-441-01	PAD, TILT FIXED		107	3-864-163-12	MANUAL, INSTRUCTION	
103	* 4-065-436-01	CUSHION (LOWER) (ASSY)		108	1-759-641-11	DISK, INFORMATION (V2.30) (Windows)	
104	* 4-065-434-01	INDIVIDUAL CARTON					
105	* 4-041-927-31	BAG, POLYETHYLENE					

SECTION 7 ELECTRICAL PARTS LIST



NOTE:

The components identified by shading and mark Δ are critical for safety. Replace only with part number specified.

Les composants identifiés par un trame et une marque Δ sont critiques pour la sécurité. Ne les remplacer que par une pièce portant le numéro spécifié.

When indicating parts by reference number, please include the board name.

The components identified by \square in this manual have been carefully factory-selected for each set in order to satisfy regulations regarding X-ray radiation. Should replacement be required, replace only with the value originally used.

- All variable and adjustable resistors have characteristic curve B, unless otherwise noted.

RESISTORS

- All resistors are in ohms
- F : nonflammable
- Items marked " * " are not stocked since they are seldom required for routine service. Some delay should be anticipated when ordering these items.

CAPACITORS

MF : μ F

COILS

UH : μ H

REF.NO.	PART NO.	DESCRIPTION	REMARK	REF.NO.	PART NO.	DESCRIPTION	REMARK
	* 8-933-326-00	AA BOARD, COMPLETE *****			<IC>		
		<CAPACITOR>		IC804	8-759-541-28	IC CXD8770Q	
		C800 1-164-004-11 CERAMIC CHIP 0.1MF	10% 25V	IC805	8-759-058-50	IC XRA10324AF	
		C802 1-164-004-11 CERAMIC CHIP 0.1MF	10% 25V	IC807	8-759-011-65	IC MC74HC4053F	
		C804 1-107-823-11 CERAMIC CHIP 0.47MF	10% 16V		<TRANSISTOR>		
		C805 1-126-786-11 ELECT 47MF	20% 16V	Q801	8-729-120-28	TRANSISTOR 2SC1623-L5L6	
		C808 1-163-099-00 CERAMIC CHIP 18PF	5% 50V	Q803	8-729-120-28	TRANSISTOR 2SC1623-L5L6	
		C809 1-163-099-00 CERAMIC CHIP 18PF	5% 50V	Q805	8-729-120-28	TRANSISTOR 2SC1623-L5L6	
		C810 1-107-823-11 CERAMIC CHIP 0.47MF	10% 16V	Q806	8-729-216-22	TRANSISTOR 2SA1162-G	
		C814 1-164-004-11 CERAMIC CHIP 0.1MF	10% 25V	Q807	8-729-216-22	TRANSISTOR 2SA1162-G	
		C820 1-164-004-11 CERAMIC CHIP 0.1MF	10% 25V	Q808	8-729-216-22	TRANSISTOR 2SA1162-G	
		C821 1-164-489-11 CERAMIC CHIP 0.22MF	10% 16V	Q809	8-729-120-28	TRANSISTOR 2SC1623-L5L6	
		C822 1-126-795-11 ELECT 10MF	20% 25V	Q810	8-729-120-28	TRANSISTOR 2SC1623-L5L6	
		C823 1-164-004-11 CERAMIC CHIP 0.1MF	10% 25V		<RESISTOR>		
		C824 1-126-795-11 ELECT 10MF	20% 25V	R800	1-216-067-00	RES,CHIP 5.6K	5% 1/10W
		C825 1-126-795-11 ELECT 10MF	20% 25V	R802	1-216-013-00	RES,CHIP 33	5% 1/10W
		C827 1-107-823-11 CERAMIC CHIP 0.47MF	10% 16V	R803	1-216-057-00	RES,CHIP 2.2K	5% 1/10W
		C828 1-164-004-11 CERAMIC CHIP 0.1MF	10% 25V	R804	1-216-067-00	RES,CHIP 5.6K	5% 1/10W
		C829 1-107-823-11 CERAMIC CHIP 0.47MF	10% 16V	R805	1-216-013-00	RES,CHIP 33	5% 1/10W
		C830 1-164-004-11 CERAMIC CHIP 0.1MF	10% 25V	R806	1-216-057-00	RES,CHIP 2.2K	5% 1/10W
		C832 1-164-004-11 CERAMIC CHIP 0.1MF	10% 25V	R807	1-216-067-00	RES,CHIP 5.6K	5% 1/10W
		C833 1-164-004-11 CERAMIC CHIP 0.1MF	10% 25V	R808	1-216-049-91	RES,CHIP 1K	5% 1/10W
		C834 1-164-004-11 CERAMIC CHIP 0.1MF	10% 25V	R809	1-216-013-00	RES,CHIP 33	5% 1/10W
		C835 1-164-004-11 CERAMIC CHIP 0.1MF	10% 25V	R810	1-216-057-00	RES,CHIP 2.2K	5% 1/10W
		<CONNECTOR>		R811	1-216-121-91	RES,CHIP 1M	5% 1/10W
CN800	1-569-515-11	PIN, CONNECTOR 14P		R813	1-216-067-00	RES,CHIP 5.6K	5% 1/10W
CN801	1-785-254-11	PIN, CONNECTOR (PC BOARD) 13P		R814	1-216-057-00	RES,CHIP 2.2K	5% 1/10W
		<DIODE>		R815	1-216-057-00	RES,CHIP 2.2K	5% 1/10W
D800	8-719-404-49	DIODE MA111		R816	1-216-057-00	RES,CHIP 2.2K	5% 1/10W
D801	8-719-404-49	DIODE MA111		R817	1-216-067-00	RES,CHIP 5.6K	5% 1/10W
D802	8-719-404-49	DIODE MA111		R818	1-216-067-00	RES,CHIP 5.6K	5% 1/10W
D803	8-719-158-18	ZENER DIODE RD5.6SB3		R819	1-216-121-91	RES,CHIP 1M	5% 1/10W
D804	8-719-404-49	DIODE MA111		R820	1-216-049-91	RES,CHIP 1K	5% 1/10W
				R821	1-216-637-11	METAL CHIP 270	0.50%1/10W
D805	8-719-404-49	DIODE MA111		R822	1-216-665-11	METAL CHIP 3.9K	0.50%1/10W
				R823	1-216-089-91	RES,CHIP 47K	5% 1/10W
				R824	1-216-097-91	RES,CHIP 100K	5% 1/10W
				R825	1-216-065-91	RES,CHIP 4.7K	5% 1/10W

The components identified by shading and mark Δ are critical for safety. Replace only with part number specified.

Les composants identifiés par un trame et une marque Δ sont critiques pour la sécurité. Ne les remplacer que par une pièce portant le numéro spécifié.



REF.NO.	PART NO.	DESCRIPTION	REMARK	REF.NO.	PART NO.	DESCRIPTION	REMARK
C103	1-163-085-00	CERAMIC CHIP 2PF	0.25PF 50V	D305	8-719-970-83	DIODE HSS82	
C105	1-164-004-11	CERAMIC CHIP 0.1MF	10% 25V	D306	8-719-970-83	DIODE HSS82	
C106	1-137-528-11	FILM 0.1MF	10% 250V				
C201	1-107-823-11	CERAMIC CHIP 0.47MF	10% 16V			<FERRITE BEAD>	
C202	1-110-591-91	ELECT 4.7MF	20% 50V	FB001	1-412-911-11	FERRITE	1.1UH
C203	1-163-085-00	CERAMIC CHIP 2PF	0.25PF 50V	FB005	1-412-911-11	FERRITE	1.1UH
C204	1-216-295-91	SHORT 0		FB007	1-412-911-11	FERRITE	1.1UH
C205	1-164-004-11	CERAMIC CHIP 0.1MF	10% 25V	FB011	1-412-911-11	FERRITE	1.1UH
C206	1-137-528-11	FILM 0.1MF	10% 250V	FB012	1-216-295-91	SHORT	0
C301	1-107-823-11	CERAMIC CHIP 0.47MF	10% 16V	FB013	1-216-295-91	SHORT	0
C302	1-110-591-91	ELECT 4.7MF	20% 50V	FB014	1-216-295-91	SHORT	0
C303	1-163-085-00	CERAMIC CHIP 2PF	0.25PF 50V	FB015	1-543-961-11	FERRITE	
C304	1-216-295-91	SHORT 0		FB016	1-216-295-91	SHORT	0
C305	1-164-004-11	CERAMIC CHIP 0.1MF	10% 25V	FB101	1-500-419-21	FERRITE	
C306	1-137-528-11	FILM 0.1MF	10% 250V	FB102	1-500-419-21	FERRITE	
		<CONNECTOR>		FB110	1-412-911-11	FERRITE	1.1UH
CN301*	1-766-179-11	PIN, CONNECTOR (PC BOARD) 2P		FB201	1-500-419-21	FERRITE	
CN302	1-695-915-11	TAB (CONTACT)		FB202	1-500-419-21	FERRITE	
CN303	1-695-915-11	TAB (CONTACT)		FB210	1-412-911-11	FERRITE	1.1UH
CN304	1-695-915-11	TAB (CONTACT)		FB301	1-500-419-21	FERRITE	
CN305*	1-564-526-11	PLUG, CONNECTOR 11P		FB302	1-500-419-21	FERRITE	
CN306*	1-564-525-11	PLUG, CONNECTOR 10P		FB310	1-412-911-11	FERRITE	1.1UH
CN307*	1-564-512-11	PLUG, CONNECTOR 9P				<FILTER>	
CN308	1-695-915-11	TAB (CONTACT)		FL001	1-412-911-31	FERRITE	
CN309	1-564-524-11	PLUG, CONNECTOR 9P		FL101	1-412-911-31	FERRITE	
CN310*	1-564-507-11	PLUG, CONNECTOR 4P		FL201	1-412-911-31	FERRITE	
CN312	1-785-221-12	PIN, CONNECTOR (PC BOARD) 13P		FL301	1-412-911-31	FERRITE	
CN313	1-785-222-12	PIN, CONNECTOR (PC BOARD) 14P				<TERMINAL>	
CN314	1-564-517-11	PLUG, CONNECTOR 2P		GT101*	1-537-738-21	TERMINAL, EARTH	
CN315*	1-564-508-11	PLUG, CONNECTOR 5P		GT102*	1-537-738-21	TERMINAL, EARTH	
CN316*	1-564-518-11	PLUG, CONNECTOR 3P		GT103*	1-537-738-21	TERMINAL, EARTH	
		<DIODE>		GT104*	1-537-738-21	TERMINAL, EARTH	
D001	8-719-109-89	ZENER DIODE RD5.6ESB2				<IC>	
D003	8-719-109-89	ZENER DIODE RD5.6ESB2		IC001	8-759-474-78	IC MM1382	
D005	8-719-911-19	DIODE 1SS119-25		IC002	8-759-559-99	IC LM2405T-C	
D006	8-719-911-19	DIODE 1SS119-25		IC003	8-759-541-26	IC LSC4514P2	
D007	8-719-109-89	ZENER DIODE RD5.6ESB2		IC004	8-759-434-40	IC TDA6103Q/N3,112	
D008	8-719-109-89	ZENER DIODE RD5.6ESB2		IC005	8-759-100-96	IC uPC4558G2	
D009	8-719-404-49	DIODE MA111		IC006	8-759-543-53	IC CXA8075S	
D013	8-719-404-49	DIODE MA111		IC008	8-759-542-46	IC M62392FP	
D014	8-719-911-19	DIODE 1SS119-25		IC009	8-759-925-72	IC SN74HC02ANS	
D015	8-719-105-99	ZENER DIODE RD6.2M-B1				<JACK>	
D101	8-719-800-76	DIODE 1SS226		J001 Δ	1-251-598-11	SOCKET, PICTURE TUBE	
D104	8-719-970-83	DIODE HSS82				<COIL>	
D105	8-719-970-83	DIODE HSS82		L002	1-410-682-31	INDUCTOR 470UH	
D106	8-719-970-83	DIODE HSS82					
D201	8-719-800-76	DIODE 1SS226					
D204	8-719-970-83	DIODE HSS82					
D205	8-719-970-83	DIODE HSS82					
D206	8-719-970-83	DIODE HSS82					
D301	8-719-800-76	DIODE 1SS226					
D304	8-719-970-83	DIODE HSS82					

CPD-201VS



REF.NO.	PART NO.	DESCRIPTION	REMARK	REF.NO.	PART NO.	DESCRIPTION	REMARK
L003	1-412-529-11	INDUCTOR 22UH		R053	1-219-621-91	METAL 22M	10% 1/4W
L006	1-412-537-31	INDUCTOR 100UH		R055	1-216-025-91	RES,CHIP 100	5% 1/10W
L101	1-414-140-11	INDUCTOR 0.68UH		R056	1-216-025-91	RES,CHIP 100	5% 1/10W
L201	1-414-140-11	INDUCTOR 0.68UH		R057	1-216-049-91	RES,CHIP 1K	5% 1/10W
L301	1-414-140-11	INDUCTOR 0.68UH		R058	1-216-049-91	RES,CHIP 1K	5% 1/10W
		<TRANSISTOR>		R059	1-216-049-91	RES,CHIP 1K	5% 1/10W
Q001	8-729-032-61	TRANSISTOR 2SC5022-02		R060	1-216-073-00	RES,CHIP 10K	5% 1/10W
Q004	8-729-120-28	TRANSISTOR 2SC1623-L5L6		R061	1-216-065-91	RES,CHIP 4.7K	5% 1/10W
Q005	8-729-101-07	TRANSISTOR 2SB798-DL		R062	1-216-041-00	RES,CHIP 470	5% 1/10W
Q006	8-729-120-28	TRANSISTOR 2SC1623-L5L6		R063	1-216-037-00	RES,CHIP 330	5% 1/10W
Q007	8-729-140-47	TRANSISTOR 2SC3735-L-B35		R064	1-202-830-00	SOLID 10K	20% 1/2W
Q008	8-729-422-27	TRANSISTOR 2SD601A-Q		R065	1-216-049-91	RES,CHIP 1K	5% 1/10W
Q009	8-729-027-31	TRANSISTOR DTA124EKA-T146		R067	1-216-065-91	RES,CHIP 4.7K	5% 1/10W
Q010	8-729-120-28	TRANSISTOR 2SC1623-L5L6		R068	1-216-073-00	RES,CHIP 10K	5% 1/10W
Q011	8-729-120-28	TRANSISTOR 2SC1623-L5L6		R069	1-216-077-00	RES,CHIP 15K	5% 1/10W
		<RESISTOR>		R070	1-216-077-00	RES,CHIP 15K	5% 1/10W
R002	1-216-053-00	RES,CHIP 1.5K	5% 1/10W	R071	1-216-081-00	RES,CHIP 22K	5% 1/10W
R003	1-216-067-00	RES,CHIP 5.6K	5% 1/10W	R072	1-216-105-91	RES,CHIP 220K	5% 1/10W
R004	1-216-055-00	RES,CHIP 1.8K	5% 1/10W	R073	1-216-105-91	RES,CHIP 220K	5% 1/10W
R005	1-216-113-00	RES,CHIP 470K	5% 1/10W	R074	1-216-083-00	RES,CHIP 27K	5% 1/10W
R006	1-216-025-91	RES,CHIP 100	5% 1/10W	R075	1-216-073-00	RES,CHIP 10K	5% 1/10W
R007	1-216-049-91	RES,CHIP 1K	5% 1/10W	R081	1-216-057-00	RES,CHIP 2.2K	5% 1/10W
R014	1-216-073-00	RES,CHIP 10K	5% 1/10W	R101	1-215-394-00	METAL 75	1% 1/4W
R016	1-216-073-00	RES,CHIP 10K	5% 1/10W	R103	1-216-295-91	SHORT 0	
R017	1-216-025-91	RES,CHIP 100	5% 1/10W	R104	1-216-021-00	RES,CHIP 68	5% 1/10W
R018	1-216-025-91	RES,CHIP 100	5% 1/10W	R106	1-216-065-91	RES,CHIP 4.7K	5% 1/10W
R020	1-216-295-91	SHORT 0		R107	1-216-065-91	RES,CHIP 4.7K	5% 1/10W
R021	1-216-295-91	SHORT 0		R108	1-216-065-91	RES,CHIP 4.7K	5% 1/10W
R022	1-216-025-91	RES,CHIP 100	5% 1/10W	R109	1-216-121-91	RES,CHIP 1M	5% 1/10W
R023	1-216-025-91	RES,CHIP 100	5% 1/10W	R110	1-215-477-00	METAL 220K	1% 1/4W
R026	1-216-073-00	RES,CHIP 10K	5% 1/10W	R111	1-249-401-11	CARBON 47	5% 1/4W F
R027	1-216-073-00	RES,CHIP 10K	5% 1/10W	R112	1-216-013-00	RES,CHIP 33	5% 1/10W
R028	1-216-055-00	RES,CHIP 1.8K	5% 1/10W	R115	1-216-641-11	METAL CHIP 390	0.50% 1/10W
R029	1-216-095-00	RES,CHIP 82K	5% 1/10W	R116	1-216-081-00	RES,CHIP 22K	5% 1/10W
R030	1-216-295-91	SHORT 0		R133	1-249-407-11	CARBON 150	5% 1/4W
R031	1-216-049-91	RES,CHIP 1K	5% 1/10W	R151	1-202-549-00	SOLID 100	20% 1/2W
R032	1-216-663-11	METAL CHIP 3.3K	0.50% 1/10W	R201	1-215-394-00	METAL 75	1% 1/4W
R033	1-216-679-11	METAL CHIP 15K	0.50% 1/10W	R203	1-216-295-91	SHORT 0	
R034	1-216-025-91	RES,CHIP 100	5% 1/10W	R204	1-216-021-00	RES,CHIP 68	5% 1/10W
R035	1-216-025-91	RES,CHIP 100	5% 1/10W	R206	1-216-065-91	RES,CHIP 4.7K	5% 1/10W
R036	1-249-405-11	CARBON 100	5% 1/4W F	R207	1-216-065-91	RES,CHIP 4.7K	5% 1/10W
R037	1-216-295-91	SHORT 0		R208	1-216-065-91	RES,CHIP 4.7K	5% 1/10W
R040	1-216-113-00	RES,CHIP 470K	5% 1/10W	R209	1-216-121-91	RES,CHIP 1M	5% 1/10W
R041	1-163-085-00	CERAMIC CHIP 2PF	0.25PF 50V	R210	1-215-477-00	METAL 220K	1% 1/4W
R043	1-216-295-91	SHORT 0		R211	1-249-401-11	CARBON 47	5% 1/4W F
R045	1-216-057-00	RES,CHIP 2.2K	5% 1/10W	R212	1-216-013-00	RES,CHIP 33	5% 1/10W
R046	1-216-097-91	RES,CHIP 100K	5% 1/10W	R215	1-216-641-11	METAL CHIP 390	0.50% 1/10W
R047	1-216-073-00	RES,CHIP 10K	5% 1/10W	R216	1-216-081-00	RES,CHIP 22K	5% 1/10W
R048	1-211-885-21	METAL 2.2M	5% 1W	R233	1-247-815-91	CARBON 220	5% 1/4W
R049	1-216-101-00	RES,CHIP 150K	5% 1/10W	R251	1-202-549-00	SOLID 100	20% 1/2W
R051	1-216-049-91	RES,CHIP 1K	5% 1/10W	R301	1-215-394-00	METAL 75	1% 1/4W
R052	1-216-073-00	RES,CHIP 10K	5% 1/10W	R303	1-216-295-91	SHORT 0	
				R304	1-216-021-00	RES,CHIP 68	5% 1/10W
				R306	1-216-065-91	RES,CHIP 4.7K	5% 1/10W
				R307	1-216-065-91	RES,CHIP 4.7K	5% 1/10W
				R308	1-216-065-91	RES,CHIP 4.7K	5% 1/10W



REF.NO.	PART NO.	DESCRIPTION	REMARK	REF.NO.	PART NO.	DESCRIPTION	REMARK
R309	1-216-121-91	RES,CHIP	1M 5% 1/10W	C510	1-102-228-00	CERAMIC	470PF 10% 500V
R310	1-215-477-00	METAL	220K 1% 1/4W	C511	1-115-343-11	FILM	0.47MF 5% 400V
R311	1-249-401-11	CARBON	47 5% 1/4W F	C512	1-102-002-00	CERAMIC	680PF 10% 500V
R312	1-216-013-00	RES,CHIP	33 5% 1/10W	C513	1-126-964-11	ELECT	10MF 20% 50V
R313	1-216-025-91	RES,CHIP	100 5% 1/10W	C514	1-163-251-11	CERAMIC CHIP	100PF 5% 50V
R314	1-249-417-11	CARBON	1K 5% 1/4W F	C515	1-163-037-11	CERAMIC CHIP	0.022MF 10% 50V
R315	1-216-641-11	METAL CHIP	390 0.50% 1/10W	C517	1-130-489-00	FILM	0.033MF 5% 50V
R316	1-216-081-00	RES,CHIP	22K 5% 1/10W	C518	1-117-832-11	FILM	4700PF 3% 2KV
R333	1-249-407-11	CARBON	150 5% 1/4W	C519	1-136-064-00	FILM	2200PF 3% 1.2KV
R351	1-202-549-00	SOLID	100 20% 1/2W	C520	1-163-021-91	CERAMIC CHIP	0.01MF 10% 50V
<SPARK GAP>				C521	1-107-444-11	CERAMIC	100PF 5% 2KV
SG001	1-519-422-11	GAP, SPARK		C522	1-136-481-11	MYLAR	0.0022MF 10% 100V
SG002	1-519-422-11	GAP, SPARK		C523	1-115-520-11	FILM	0.68MF 5% 250V
SG101	1-517-499-21	GAP, SPARK		C524	1-107-955-11	ELECT	100MF 20% 200V
SG201	1-517-499-21	GAP, SPARK		C525	1-117-206-21	FILM	0.36MF 5% 250V
SG301	1-517-499-21	GAP, SPARK		C526	1-165-136-11	CERAMIC	3300PF 10% 500V
*****				C527	1-117-879-91	CAPACITOR	0.01MF 10% 250V
* A-1346-765-A D BOARD, COMPLETE				C528	1-115-349-51	CERAMIC	0.01MF 2KV
*****				C529	1-115-511-11	FILM	0.12MF 5% 250V
2-371-561-00 BUSHING (P), INSULATING (IC503)				C531	1-117-451-11	FILM	0.43MF 5% 250V
4-045-133-01 HOLDER (B), LED (D938)				C532	1-137-426-11	FILM	0.47MF 10% 100V
* 4-049-002-01 HOLDER, LED (D912)				C534	1-137-420-11	FILM	0.047MF 10% 100V
4-061-191-01 SHEET, INSULATE (IC503)				C535	1-130-489-00	FILM	0.033MF 5% 50V
4-061-192-01 SHEET, INSULATE (Q602)				C536	1-163-021-91	CERAMIC CHIP	0.01MF 10% 50V
4-382-854-01 SCREW (M3X8), P, SW (+) (Q607)				C538	1-163-021-91	CERAMIC CHIP	0.01MF 10% 50V
4-382-854-11 SCREW (M3X10), P, SW (+) (IC401,				C539	1-137-419-11	FILM	0.033MF 10% 100V
IC503, IC602, IC603, IC604, Q503, Q507,				C540	1-136-203-11	FILM	10000PF 5% 630V
Q510, Q602, Q608, D506, D601, D603,				C541	1-126-963-11	ELECT	4.7MF 20% 50V
D658)				C542	1-126-964-11	ELECT	10MF 20% 50V
4-382-854-21 SCREW (M3X14), P, SW (+) (IC702)				C543	1-163-251-11	CERAMIC CHIP	100PF 5% 50V
4-389-025-01 SCREW (M4) (EXT TOOTH WASHER)				C544	1-137-370-11	FILM	0.01MF 5% 50V
<CAPACITOR>				C545	1-163-037-11	CERAMIC CHIP	0.022MF 10% 50V
C401	1-128-528-11	ELECT	470MF 20% 25V	C546	1-163-259-91	CERAMIC CHIP	220PF 5% 50V
C402	1-106-228-00	MYLAR	0.22MF 10% 100V	C547	1-126-960-11	ELECT	1MF 20% 50V
C403	1-126-969-11	ELECT	220MF 20% 50V	C548	1-137-364-11	FILM	0.001MF 5% 50V
C404	1-126-942-61	ELECT	1000MF 20% 25V	C549	1-137-375-11	FILM	0.068MF 5% 50V
C405	1-137-371-11	FILM	0.015MF 5% 50V	C550	1-126-933-11	ELECT	100MF 20% 16V
C406	1-137-368-11	FILM	0.0047MF 5% 50V	C551	1-163-021-91	CERAMIC CHIP	0.01MF 10% 50V
C407	1-137-372-11	FILM	0.022MF 5% 50V	C552	1-163-021-91	CERAMIC CHIP	0.01MF 10% 50V
C408	1-107-713-11	ELECT	4.7MF 20% 35V	C553	1-163-009-11	CERAMIC CHIP	0.001MF 10% 50V
C409	1-124-006-11	ELECT	10MF 20% 25V	C554	1-164-004-11	CERAMIC CHIP	0.1MF 10% 25V
C410	1-164-004-11	CERAMIC CHIP	0.1MF 10% 25V	C555	1-130-495-00	FILM	0.1MF 5% 50V
C501	1-126-964-11	ELECT	10MF 20% 50V	C556	1-163-259-91	CERAMIC CHIP	220PF 5% 50V
C502	1-137-370-11	FILM	0.01MF 5% 50V	C557	1-126-965-11	ELECT	22MF 20% 50V
C503	1-102-129-00	CERAMIC	0.01MF 10% 50V	C558	1-126-960-11	ELECT	1MF 20% 50V
C504	1-162-318-11	CERAMIC	0.001MF 10% 500V	C559	1-137-368-11	FILM	0.0047MF 5% 50V
C505	1-109-843-11	CERAMIC	33PF 5% 2KV	C560	1-117-665-11	FILM	0.33MF 5% 200V
C506	1-126-960-11	ELECT	1MF 20% 50V	C561	1-163-009-11	CERAMIC CHIP	0.001MF 10% 50V
C508	1-104-665-11	ELECT	100MF 20% 25V	C562	1-126-933-11	ELECT	100MF 20% 16V
C509	1-162-117-00	CERAMIC	100PF 10% 500V	C563	1-163-005-11	CERAMIC CHIP	470PF 10% 50V
				C564	1-164-004-11	CERAMIC CHIP	0.1MF 10% 25V
				C569	1-130-495-00	FILM	0.1MF 5% 50V
				C570	1-104-665-11	ELECT	100MF 20% 25V
				C573	1-107-635-11	ELECT	4.7MF 20% 160V
				C574	1-117-879-91	CAPACITOR	0.01MF 10% 250V
				C575	1-107-955-11	ELECT	100MF 20% 200V

The components identified by shading and mark Δ are critical for safety. Replace only with part number specified.

Les composants identifiés par un trame et une marque Δ sont critiques pour la sécurité. Ne les remplacer que par une pièce portant le numéro spécifié.



REF.NO.	PART NO.	DESCRIPTION	REMARK	REF.NO.	PART NO.	DESCRIPTION	REMARK
CN504	1-695-915-11	TAB (CONTACT)		D611	8-719-911-19	DIODE 1SS119-25	
CN600	Δ 1-251-644-11	INLET, AC 3P (WITH NOISE FILTER)		D612	8-719-911-19	DIODE 1SS119-25	
CN601	1-691-960-11	PIN, CONNECTOR (PC BOARD) 3P		D613	8-719-911-19	DIODE 1SS119-25	
CN602*	1-774-511-11	CONNECTOR, BOARD TO BOARD 10P		D614	8-719-911-19	DIODE 1SS119-25	
CN605*	1-506-371-00	PIN, CONNECTOR 2P		D615	8-719-911-19	DIODE 1SS119-25	
CN607*	1-564-508-11	PLUG, CONNECTOR 5P		D618	8-719-404-49	DIODE MA111	
CN701*	1-564-511-11	PLUG, CONNECTOR 8P		D619	8-719-158-15	ZENER DIODE RD5.6SB	
CN901*	1-508-879-11	BASE POST		D621	8-719-158-15	ZENER DIODE RD5.6SB	
CN902	1-564-513-11	PLUG, CONNECTOR 10P		D622	8-719-158-15	ZENER DIODE RD5.6SB	
CN903*	1-564-512-11	PLUG, CONNECTOR 9P		D623	8-719-158-49	ZENER DIODE RD12SB2	
CN904*	1-564-509-11	PLUG, CONNECTOR 6P		D624	8-719-404-49	DIODE MA111	
		<DIODE>		D650	8-719-510-46	DIODE D1NL20	
D401	8-719-979-58	DIODE EGP10D		D651	8-719-510-46	DIODE D1NL20	
D402	8-719-109-81	ZENER DIODE RD4.7ESB2		D652	8-719-510-46	DIODE D1NL20	
D403	8-719-404-49	DIODE MA111		D653	8-719-510-46	DIODE D1NL20	
D404	8-719-404-49	DIODE MA111		D654	8-719-052-90	DIODE D1NL40-TA2	
D405	8-719-970-83	DIODE HSS82		D655	8-719-500-70	DIODE D5S4M	
D501	8-719-110-31	ZENER DIODE RD12ESB2		D656	8-719-500-70	DIODE D5S4M	
D502	8-719-047-65	DIODE SB340L-5009		D657	8-719-500-70	DIODE D5S4M	
D503	8-719-109-89	ZENER DIODE RD5.6ESB2		D658	8-719-052-91	DIODE D4SBS4-F	
D504	8-719-110-49	ZENER DIODE RD18ESB2		D662	8-719-064-37	DIODE R2KS	
D505	8-719-941-74	DIODE ERB91-02		D670	8-719-911-19	DIODE 1SS119-25	
D506	8-719-061-21	DIODE FMQ-G5FMS		D671	8-719-911-19	DIODE 1SS119-25	
D507	8-719-109-85	ZENER DIODE RD5.1ESB2		D701	8-719-158-15	ZENER DIODE RD5.6SB	
D508	8-719-986-73	DIODE RB441Q		D704	8-719-404-49	DIODE MA111	
D509	8-719-110-17	ZENER DIODE RD10ESB2		D901	8-719-404-49	DIODE MA111	
D510	8-719-028-72	DIODE RGP02-17EL-6433		D902	8-719-158-15	ZENER DIODE RD5.6SB	
D511	8-719-109-93	ZENER DIODE RD6.2ESB2		D903	8-719-404-49	DIODE MA111	
D512	8-719-911-19	DIODE 1SS119-25		D904	8-719-404-49	DIODE MA111	
D513	8-719-979-58	DIODE EGP10D		D905	8-719-404-49	DIODE MA111	
D514	8-719-970-83	DIODE HSS82		D906	8-719-404-49	DIODE MA111	
D515	8-719-979-58	DIODE EGP10D		D907	8-719-404-49	DIODE MA111	
D516	8-719-051-97	DIODE 3DL41A(LC6-15)		D908	8-719-404-49	DIODE MA111	
D517	8-719-110-67	ZENER DIODE RD27ESB2		D909	8-719-158-15	ZENER DIODE RD5.6SB	
D518	8-719-110-17	ZENER DIODE RD10ESB2		D910	8-719-158-15	ZENER DIODE RD5.6SB	
D520	8-719-028-72	DIODE RGP02-17EL-6433		D911	8-719-404-49	DIODE MA111	
D521	8-719-028-72	DIODE RGP02-17EL-6433		D912	8-719-045-19	DIODE SPB-26MVWF	
D522	8-719-911-19	DIODE 1SS119-25		D914	8-719-404-49	DIODE MA111	
D523	8-719-911-19	DIODE 1SS119-25		D915	8-719-404-49	DIODE MA111	
D524	8-719-970-83	DIODE HSS82		D916	8-719-404-49	DIODE MA111	
D525	8-719-970-83	DIODE HSS82		D917	8-719-404-49	DIODE MA111	
D526	8-719-911-19	DIODE 1SS119-25		D918	8-719-158-15	ZENER DIODE RD5.6SB	
D527	8-719-109-85	ZENER DIODE RD5.1ESB2		D919	8-719-158-15	ZENER DIODE RD5.6SB	
D550	8-719-979-58	DIODE EGP10D		D920	8-719-986-73	DIODE RB441Q	
D551	8-719-979-58	DIODE EGP10D		D922	8-719-404-49	DIODE MA111	
D601	Δ 8-719-510-53	DIODE D4SB60L		D924	8-719-404-49	DIODE MA111	
D603	8-719-051-96	DIODE FMG-G2CS		D925	8-719-404-49	DIODE MA111	
D604	8-719-911-19	DIODE 1SS119-25		D935	8-719-404-49	DIODE MA111	
D605	8-719-911-19	DIODE 1SS119-25		D936	8-719-404-49	DIODE MA111	
D606	8-719-510-46	DIODE D1NL20		D937	8-719-404-49	DIODE MA111	
D607	8-719-911-19	DIODE 1SS119-25		D938	8-719-311-90	DIODE SEL1922D-C	
D608	8-719-110-49	ZENER DIODE RD18ESB2		D939	8-719-986-73	DIODE RB441Q	
D609	8-719-510-46	DIODE D1NL20				<FUSE>	
				F601	Δ 1-576-231-11	FUSE (H.B.C.) (4A/250V)	

CPD-201VS



Les composants identifiés par un trame et une marque Δ sont critiques pour la sécurité. Ne les remplacer que par une pièce portant le numéro spécifié.

The components identified by shading and mark Δ are critical for safety. Replace only with part number specified.

REF.NO.	PART NO.	DESCRIPTION	REMARK	REF.NO.	PART NO.	DESCRIPTION	REMARK
	1-533-223-11	HOLDER, FUSE ; F601			<COIL>		
		<FERRITE BEAD>		L501	1-412-531-31	INDUCTOR 33UH	
				L502	1-412-531-31	INDUCTOR 33UH	
				L503	1-411-594-41	COIL, CHOKE 5mmH	
				L506	1-412-545-11	INDUCTOR 470UH	
				L509	1-416-860-11	COIL, HORIZONTAL LINEARITY	
				L510	1-416-367-11	COIL, HORIZONTAL CENTER	
				L601	1-406-663-21	COIL, CHOKE 47UH	
				L602 Δ	1-412-529-41	INDUCTOR 22UH	
				L603	1-412-537-31	INDUCTOR 100UH	
				L650	1-412-529-11	INDUCTOR 22UH	
				L651	1-410-645-31	INDUCTOR 100UH	
				L652	1-412-529-11	INDUCTOR 22UH	
				L653	1-412-529-11	INDUCTOR 22UH	
				L901	1-412-537-31	INDUCTOR 100UH	
		<TERMINAL>			<FILTER>		
	GT001*	1-537-738-21	TERMINAL, EARTH		LF601 Δ	1-429-180-11	TRANSFORMER, LINE FILTER
		<IC>				<IC LINK>	
	IC401	8-759-444-83	IC LA7840L		PS600 Δ	1-533-597-31	LINK, IC (5A/90V AC, 60V DC)
	IC501 Δ	8-759-478-76	IC uPC5021-109		PS601 Δ	1-532-727-91	LINK, IC (0.25A/150V)
	IC502	8-759-803-42	IC LA6500-FA				
	IC503	8-759-803-42	IC LA6500-FA				
	IC602	8-759-701-88	IC NJM7912FA				
	IC603	8-759-450-47	IC BA05T				
	IC604	8-759-513-72	IC PQ12RF11				
	IC605	8-749-010-64	PHOTO COUPLER PC123F2				
	IC611	8-749-012-13	IC DM-58				
	IC612	8-749-013-76	IC PQ6RD83B				
	IC701	8-759-478-66	IC CXA8070P				
	IC702	8-749-014-32	IC STK392-910A				
	IC900	8-759-525-10	IC TC7SET08F(TE85L)				
	IC901	8-759-541-29	IC ST72751N9B1/LAM				
	IC902	8-759-537-27	IC CXA8071AP				
	IC904	8-759-165-80	IC PST600C-T				
	IC905	8-759-527-71	IC M24C08-BN6				
		<CHIP CONDUCTOR>				<TRANSISTOR>	
	JR002	1-216-296-91	SHORT 0	Q501	8-729-120-28	TRANSISTOR 2SC1623-L5L6	
	JR003	1-216-295-91	SHORT 0	Q502	8-729-026-49	TRANSISTOR 2SA1037AK-T146-R	
	JR004	1-216-296-91	SHORT 0	Q503	8-729-015-28	TRANSISTOR IRFI9630GS	
	JR005	1-216-296-91	SHORT 0	Q504	8-729-031-89	TRANSISTOR 2SC3941A-Q(TA)	
	JR006	1-216-296-91	SHORT 0	Q505	8-729-119-76	TRANSISTOR 2SA1175-HFE	
	JR007	1-216-296-91	SHORT 0	Q506	8-729-119-76	TRANSISTOR 2SA1175-HFE	
	JR008	1-216-295-91	SHORT 0	Q507	8-729-041-29	TRANSISTOR BU2522AX-ON5008	
	JR009	1-216-296-91	SHORT 0	Q508	8-729-119-78	TRANSISTOR 2SC2785-HFE	
	JR010	1-216-295-91	SHORT 0	Q509	8-729-043-28	TRANSISTOR PDTC124EK-115	
	JR011	1-216-296-91	SHORT 0	Q510	8-729-042-42	TRANSISTOR 2SK2101-01MR-F141	
	JR012	1-216-296-91	SHORT 0	Q511	8-729-042-34	TRANSISTOR IRFU110A	
	JR013	1-216-296-91	SHORT 0	Q512	8-729-041-95	TRANSISTOR IRLI540GLF33	
	JR014	1-216-296-91	SHORT 0	Q515	8-729-041-95	TRANSISTOR IRLI540GLF33	
	JR015	1-216-296-91	SHORT 0	Q516	8-729-041-93	TRANSISTOR IRLI530GLF33	
	JR019	1-216-295-91	SHORT 0	Q517	8-729-326-11	TRANSISTOR 2SC2611	
	JR020	1-216-295-91	SHORT 0	Q518	8-729-140-50	TRANSISTOR 2SC3209LK	
	JR021	1-216-295-91	SHORT 0	Q520	8-729-015-28	TRANSISTOR IRFI9630GS	
				Q521	8-729-119-76	TRANSISTOR 2SA1175-HFE	
				Q522	8-729-026-49	TRANSISTOR 2SA1037AK-T146-R	
				Q523	8-729-120-28	TRANSISTOR 2SC1623-L5L6	
				Q601	8-729-119-76	TRANSISTOR 2SA1175-HFE	
				Q602	8-729-037-98	TRANSISTOR 2SK2194F08	
				Q603	8-729-043-33	TRANSISTOR PDTA124EK-115	
				Q604	8-729-043-28	TRANSISTOR PDTC124EK-115	
				Q605	8-729-120-28	TRANSISTOR 2SC1623-L5L6	
				Q606	8-729-041-93	TRANSISTOR IRLI530GLF33	
				Q607	8-729-209-15	TRANSISTOR 2SD2012	
				Q608	8-729-039-65	TRANSISTOR MX0541B-F	
				Q609	8-729-043-33	TRANSISTOR PDTA124EK-115	

The components identified by shading and mark Δ are critical for safety. Replace only with part number specified.

Les composants identifiés par un trame Δ sont critiques pour la sécurité. Ne les remplacer que par une pièce portant le numéro spécifié.



REF.NO.	PART NO.	DESCRIPTION	REMARK	REF.NO.	PART NO.	DESCRIPTION	REMARK
Q610	8-729-322-37	TRANSISTOR 2SJ175		R522	1-249-401-11	CARBON 47	5% 1/4W
Q611	8-729-043-28	TRANSISTOR PDTC124EK-115		R523	1-216-089-91	RES,CHIP 47K	5% 1/10W
Q654	8-729-119-76	TRANSISTOR 2SA1175-HFE		R525	1-249-417-11	CARBON 1K	5% 1/4W F
Q670	8-729-119-78	TRANSISTOR 2SC2785-HFE		R526	1-249-425-11	CARBON 4.7K	5% 1/4W
Q671	8-729-200-17	TRANSISTOR 2SA1091-O		R527	1-249-429-11	CARBON 10K	5% 1/4W
Q672	8-729-120-28	TRANSISTOR 2SC1623-L5L6		R528	1-247-863-91	CARBON 22K	5% 1/4W
Q673	8-729-026-49	TRANSISTOR 2SA1037AK-T146-R		R529	1-249-429-11	CARBON 10K	5% 1/4W F
Q901	8-729-120-28	TRANSISTOR 2SC1623-L5L6		R530	1-216-474-11	METAL OXIDE 82	5% 3W F
Q902	8-729-120-28	TRANSISTOR 2SC1623-L5L6		R531	1-216-474-11	METAL OXIDE 82	5% 3W F
Q903	8-729-120-28	TRANSISTOR 2SC1623-L5L6		R532	1-249-385-11	CARBON 2.2	5% 1/4W F
Q904	8-729-120-28	TRANSISTOR 2SC1623-L5L6		R533	1-249-417-11	CARBON 1K	5% 1/4W F
Q905	8-729-900-51	TRANSISTOR DTA114TK		R534	1-249-405-11	CARBON 100	5% 1/4W F
		<RESISTOR>		R535	1-216-089-91	RES,CHIP 47K	5% 1/10W
JW105	1-247-807-31	CARBON 100	5% 1/4W	R536	1-249-417-11	CARBON 1K	5% 1/4W F
R401	1-249-383-11	CARBON 1.5	5% 1/4W F	R537	1-216-089-91	RES,CHIP 47K	5% 1/10W
R402	1-215-866-11	METAL OXIDE 330	5% 1W F	R538	1-215-905-11	METAL OXIDE 10	5% 3W F
R403	1-214-796-00	METAL 1.5	1% 1/2W	R539	1-215-905-11	METAL OXIDE 10	5% 3W F
R404	1-215-443-00	METAL 8.2K	1% 1/4W	R540 Δ	1-215-476-91	METAL 200K	1% 1/4W
R405	1-214-796-00	METAL 1.5	1% 1/2W	R541	1-215-421-00	METAL 1K	1% 1/4W
R406	1-216-677-11	METAL CHIP 12K	0.50%1/10W	R542	1-215-421-00	METAL 1K	1% 1/4W
R407	1-216-659-11	METAL CHIP 2.2K	0.50%1/10W	R543	1-249-389-11	CARBON 4.7	5% 1/4W F
R408	1-216-081-00	RES,CHIP 22K	5% 1/10W	R544	1-215-493-00	METAL 1M	1% 1/4W
R409	1-216-671-11	METAL CHIP 6.8K	0.50%1/10W	R545	1-216-691-11	METAL CHIP 47K	0.50%1/10W
R410	1-216-677-11	METAL CHIP 12K	0.50%1/10W	R546	1-216-687-11	METAL CHIP 33K	0.50%1/10W
R411	1-216-691-11	METAL CHIP 47K	0.50%1/10W	R547	1-215-482-00	METAL 360K	1% 1/4W
R412	1-216-353-00	METAL OXIDE 2.2	5% 1W F	R548	1-215-423-00	METAL 1.2K	1% 1/4W
R451	1-215-451-00	METAL 18K	1% 1/4W	R549	1-215-462-00	METAL 51K	1% 1/4W
R452	1-215-421-00	METAL 1K	1% 1/4W	R550	1-215-423-00	METAL 1.2K	1% 1/4W
R453	1-215-445-00	METAL 10K	1% 1/4W	R551	1-216-683-11	METAL CHIP 22K	0.50%1/10W
R454	1-215-445-00	METAL 10K	1% 1/4W	R552	1-215-463-00	METAL 56K	1% 1/4W
R455	1-218-762-11	METAL CHIP 270K	0.50%1/10W	R553	1-216-699-11	METAL CHIP 100K	0.50%1/10W
R498	1-216-659-11	METAL CHIP 2.2K	0.50%1/10W	R554	1-218-756-11	METAL CHIP 150K	0.50%1/10W
R500	1-249-377-11	CARBON 0.47	5% 1/4W F	R555	1-216-691-11	METAL CHIP 47K	0.50%1/10W
R501	1-247-807-31	CARBON 100	5% 1/4W	R556	1-216-681-11	METAL CHIP 18K	0.50%1/10W
R502	1-216-103-00	RES,CHIP 180K	5% 1/10W	R557	1-216-675-11	METAL CHIP 10K	0.50%1/10W
R503	1-216-065-91	RES,CHIP 4.7K	5% 1/10W	R558	1-216-661-11	METAL CHIP 2.7K	0.50%1/10W
R504	1-249-377-11	CARBON 0.47	5% 1/4W F	R559	1-216-679-11	METAL CHIP 15K	0.50%1/10W
R505	1-216-073-00	RES,CHIP 10K	5% 1/10W	R560	1-216-474-11	METAL OXIDE 82	5% 3W F
R506	1-215-481-00	METAL 330K	1% 1/4W	R561	1-215-447-00	METAL 12K	1% 1/4W
R507	1-215-427-00	METAL 1.8K	1% 1/4W	R562	1-249-383-11	CARBON 1.5	5% 1/4W F
R508	1-247-807-31	CARBON 100	5% 1/4W	R563	1-216-089-91	RES,CHIP 47K	5% 1/10W
R509	1-247-863-91	CARBON 22K	5% 1/4W	R564	1-215-481-00	METAL 330K	1% 1/4W
R510	1-216-081-00	RES,CHIP 22K	5% 1/10W	R565	1-215-859-00	METAL OXIDE 22	5% 1W F
R511	1-249-381-11	CARBON 1	5% 1/4W F	R566	1-216-073-00	RES,CHIP 10K	5% 1/10W
R512	1-249-389-11	CARBON 4.7	5% 1/4W	R567	1-249-437-11	CARBON 47K	5% 1/4W
R513	1-215-888-00	METAL OXIDE 220	5% 2W F	R568	1-216-635-11	METAL CHIP 220	0.50%1/10W
R514	1-216-081-00	RES,CHIP 22K	5% 1/10W	R569	1-249-417-11	CARBON 1K	5% 1/4W
R515	1-215-423-00	METAL 1.2K	1% 1/4W	R570	1-215-926-00	METAL OXIDE 33K	5% 3W F
R516	9-910-999-31	METAL 150	1% 1/2W	R571	1-249-437-11	CARBON 47K	5% 1/4W
R517	1-216-393-00	METAL OXIDE 2.2	5% 3W F	R572	1-247-887-00	CARBON 220K	5% 1/4W
R518	1-216-393-00	METAL OXIDE 2.2	5% 3W F	R573	1-215-888-00	METAL OXIDE 220	5% 2W F
R519	1-216-073-00	RES,CHIP 10K	5% 1/10W	R574	1-216-447-00	METAL OXIDE 27	5% 2W F
R520	1-249-397-11	CARBON 22	5% 1/4W F	R575	1-247-887-00	CARBON 220K	5% 1/4W
				R576	1-216-077-00	RES,CHIP 15K	5% 1/10W
				R577	1-249-429-11	CARBON 10K	5% 1/4W
				R578	1-215-888-00	METAL OXIDE 220	5% 2W F
				R579	1-216-447-00	METAL OXIDE 27	5% 2W F
				R580	1-249-397-11	CARBON 22	5% 1/4W F

CPD-201VS



Les composants identifiés par un tréma et une marque Δ sont critiques pour la sécurité. Ne les remplacer que par une pièce portant le numéro spécifié.

The components identified by shading and mark Δ are critical for safety. Replace only with part number specified.

REF.NO.	PART NO.	DESCRIPTION	REMARK	REF.NO.	PART NO.	DESCRIPTION	REMARK
R583	1-216-073-00	RES,CHIP	10K	5%	1/10W	R646	1-216-073-00 RES,CHIP 10K 5% 1/10W
R584	1-216-065-91	RES,CHIP	4.7K	5%	1/10W	R650	1-249-377-11 CARBON 0.47 5% 1/4W F
R585	1-260-099-11	CARBON	1K	5%	1/2W	R651	1-249-377-11 CARBON 0.47 5% 1/4W F
R586	1-260-103-11	CARBON	2.2K	5%	1/2W	R652	1-249-377-11 CARBON 0.47 5% 1/4W F
R587	1-216-049-91	RES,CHIP	1K	5%	1/10W	R653	1-249-381-11 CARBON 1 5% 1/4W F
R589	1-249-425-11	CARBON	4.7K	5%	1/4W	R654	1-249-377-11 CARBON 0.47 5% 1/4W F
R590	1-215-453-00	METAL	22K	1%	1/4W	R655	1-249-377-11 CARBON 0.47 5% 1/4W F
R591	1-216-073-00	RES,CHIP	10K	5%	1/10W	R660	1-249-430-11 CARBON 12K 5% 1/4W F
R594	1-215-493-00	METAL	1M	1%	1/4W	R661	1-249-417-11 CARBON 1K 5% 1/4W
R595	9-910-999-31	METAL	150	1%	1/2W	R662	1-247-895-91 CARBON 470K 5% 1/4W
R596	1-249-421-11	CARBON	2.2K	5%	1/4W	R666	1-216-073-00 RES,CHIP 10K 5% 1/10W
R597	1-249-377-11	CARBON	0.47	5%	1/4W F	R667	1-249-429-11 CARBON 10K 5% 1/4W
R598	1-216-049-91	RES,CHIP	1K	5%	1/10W	R669	1-249-425-11 CARBON 4.7K 5% 1/4W
R599	1-249-377-11	CARBON	0.47	5%	1/4W F	R670	1-216-065-91 RES,CHIP 4.7K 5% 1/10W
R600	1-249-421-11	CARBON	2.2K	5%	1/4W	R671	1-249-425-11 CARBON 4.7K 5% 1/4W
R601	1-216-049-91	RES,CHIP	1K	5%	1/10W	R674	1-216-641-11 METAL CHIP 390 0.50%1/10W
R602 Δ	1-205-998-11	CEMENTED	1	5%	10W	R675	1-215-477-00 METAL 220K 1% 1/4W
R603	1-218-642-11	METAL OXIDE	100K	5%	1W F	R676	1-216-049-91 RES,CHIP 1K 5% 1/10W
R604	1-249-429-11	CARBON	10K	5%	1/4W	R677	1-247-883-00 CARBON 150K 5% 1/4W
R605	1-249-437-11	CARBON	47K	5%	1/4W	R678	1-247-895-91 CARBON 470K 5% 1/4W
R606	1-249-393-11	CARBON	10	5%	1/4W F	R679	1-216-073-00 RES,CHIP 10K 5% 1/10W
R607 Δ	1-202-882-91	SOLID	560K	20%	1/2W	R680	1-216-073-00 RES,CHIP 10K 5% 1/10W
R608	1-249-389-11	CARBON	4.7	5%	1/4W F	R681	1-216-073-00 RES,CHIP 10K 5% 1/10W
R609	1-216-073-00	RES,CHIP	10K	5%	1/10W	R701	1-216-025-91 RES,CHIP 100 5% 1/10W
R610	1-216-381-11	METAL OXIDE	0.22	5%	3W F	R702	1-216-025-91 RES,CHIP 100 5% 1/10W
R611	1-216-049-91	RES,CHIP	1K	5%	1/10W	R703	1-260-092-11 CARBON 270 5% 1/2W
R614	1-249-377-11	CARBON	0.47	5%	1/4W F	R704	1-216-061-00 RES,CHIP 3.3K 5% 1/10W
R615	1-202-933-61	FUSIBLE	0.1	10%	1/2W F	R705	1-216-667-11 METAL CHIP 4.7K 0.50%1/10W
R616	1-216-073-00	RES,CHIP	10K	5%	1/10W	R706	1-216-667-11 METAL CHIP 4.7K 0.50%1/10W
R617	1-216-065-91	RES,CHIP	4.7K	5%	1/10W	R707	1-215-445-00 METAL 10K 1% 1/4W
R619	1-215-481-00	METAL	330K	1%	1/4W	R708	1-215-445-00 METAL 10K 1% 1/4W
R620	1-216-049-91	RES,CHIP	1K	5%	1/10W	R709	1-216-675-11 METAL CHIP 10K 0.50%1/10W
R622	9-910-999-31	METAL	150	1%	1/2W	R710	1-216-675-11 METAL CHIP 10K 0.50%1/10W
R623	1-215-482-00	METAL	360K	1%	1/4W	R711	1-216-346-00 METAL OXIDE 0.56 5% 1W F
R624	1-215-479-00	METAL	270K	1%	1/4W	R712	1-215-863-11 METAL OXIDE 100 5% 1W F
R625	1-215-481-00	METAL	330K	1%	1/4W	R713	1-216-349-00 METAL OXIDE 1 5% 1W F
R626	1-216-081-00	RES,CHIP	22K	5%	1/10W	R716	1-215-863-11 METAL OXIDE 100 5% 1W F
R627	1-215-481-00	METAL	330K	1%	1/4W	R717	1-216-353-00 METAL OXIDE 2.2 5% 1W F
R628	1-215-481-00	METAL	330K	1%	1/4W	R718	1-215-863-11 METAL OXIDE 100 5% 1W F
R629	1-215-461-00	METAL	47K	1%	1/4W	R719	1-216-679-11 METAL CHIP 15K 0.50%1/10W
R630	1-249-421-11	CARBON	2.2K	5%	1/4W	R724	1-216-423-11 METAL OXIDE 27 5% 1W F
R631	1-218-642-11	METAL OXIDE	100K	5%	1W F	R727	1-216-679-11 METAL CHIP 15K 0.50%1/10W
R632	1-218-642-11	METAL OXIDE	100K	5%	1W F	R728	1-215-863-11 METAL OXIDE 100 5% 1W F
R633	1-216-073-00	RES,CHIP	10K	5%	1/10W	R729	1-216-353-00 METAL OXIDE 2.2 5% 1W F
R634	1-218-642-11	METAL OXIDE	100K	5%	1W F	R730	1-216-422-11 METAL OXIDE 18 5% 1W F
R636	1-249-389-11	CARBON	4.7	5%	1/4W	R901	1-247-807-31 CARBON 100 5% 1/4W
R637	1-249-389-11	CARBON	4.7	5%	1/4W	R902	1-216-025-91 RES,CHIP 100 5% 1/10W
R638	1-247-791-91	CARBON	22	5%	1/4W	R903	1-216-049-91 RES,CHIP 1K 5% 1/10W
R639	1-247-791-91	CARBON	22	5%	1/4W	R904	1-216-049-91 RES,CHIP 1K 5% 1/10W
R640	1-220-926-11	FUSIBLE	0.47	10%	1/2W F	R905	1-216-025-91 RES,CHIP 100 5% 1/10W
R641	1-216-089-91	RES,CHIP	47K	5%	1/10W	R906	1-216-073-00 RES,CHIP 10K 5% 1/10W
R642	1-247-807-31	CARBON	100	5%	1/4W	R907	1-260-087-11 CARBON 100 5% 1/2W
R643	1-216-065-91	RES,CHIP	4.7K	5%	1/10W	R908	1-216-648-11 METAL CHIP 750 0.50%1/10W
R644	1-216-081-00	RES,CHIP	22K	5%	1/10W	R909	1-216-648-11 METAL CHIP 750 0.50%1/10W
R645	1-216-073-00	RES,CHIP	10K	5%	1/10W	R910	1-216-033-00 RES,CHIP 220 5% 1/10W



REF.NO.	PART NO.	DESCRIPTION	REMARK	REF.NO.	PART NO.	DESCRIPTION	REMARK
	* 8-933-240-00	DA BOARD, COMPLETE		R1641	1-216-073-00	RES,CHIP 10K 5% 1/10W	
	*****				*****		
	<CAPACITOR>				* A-1373-698-A U BOARD, COMPLETE		
	*****				*****		
						4-382-854-11	SCREW (M3X10), P, SW (+) (IC5201)
	<CAPACITOR>				<CAPACITOR>		
C1608	1-163-275-11	CERAMIC CHIP 0.001MF	5% 50V	C5021	1-163-038-91	CERAMIC CHIP 0.1MF	25V
C1609	1-164-004-11	CERAMIC CHIP 0.1MF	10% 25V	C5022	1-126-965-11	ELECT 22MF	20% 50V
C1610	1-163-005-11	CERAMIC CHIP 470PF	10% 50V	C5202	1-126-964-11	ELECT 10MF	20% 50V
C1611	1-163-003-11	CERAMIC CHIP 330PF	10% 50V	C5203	1-126-964-11	ELECT 10MF	20% 50V
C1612	1-163-021-91	CERAMIC CHIP 0.01MF	10% 50V	C5205	1-107-698-11	ELECT 10MF	20% 25V
C1615	1-164-004-11	CERAMIC CHIP 0.1MF	10% 25V	C5206	1-107-698-11	ELECT 10MF	20% 25V
C1616	1-163-009-11	CERAMIC CHIP 0.001MF	10% 50V	C5207	1-164-695-11	CERAMIC CHIP 0.0022MF	5% 50V
C1618	1-164-004-11	CERAMIC CHIP 0.1MF	10% 25V	C5208	1-164-695-11	CERAMIC CHIP 0.0022MF	5% 50V
C1626	1-164-004-11	CERAMIC CHIP 0.1MF	10% 25V	C5209	1-164-344-11	CERAMIC CHIP 0.068MF	10% 25V
	<CONNECTOR>			C5210	1-163-809-11	CERAMIC CHIP 0.047MF	10% 25V
CN1600*	1-774-512-11	CONNECTOR, BPARD TO BOARD 10P		C5211	1-163-809-11	CERAMIC CHIP 0.047MF	10% 25V
	<DIODE>			C5212	1-163-038-91	CERAMIC CHIP 0.1MF	25V
D1604	8-719-977-81	ZENER DIODE DTZ33B		C5213	1-126-965-11	ELECT 22MF	20% 50V
D1605	8-719-056-95	ZENER DIODE UDZ-TE-17-22B		C5214	1-104-664-11	ELECT 47MF	20% 25V
D1610	8-719-404-49	DIODE MA111		C5215	1-163-021-91	CERAMIC CHIP 0.01MF	10% 50V
	<IC>			C5217	1-163-989-11	CERAMIC CHIP 0.033MF	10% 25V
IC1601	8-759-462-65	IC TK75003D		C5218	1-104-663-11	ELECT 33MF	20% 25V
IC1603	8-759-198-31	IC uPC1093J-1-T		C5219	1-163-038-91	CERAMIC CHIP 0.1MF	25V
	<CHIP CONDUCTOR>			C5220	1-164-344-11	CERAMIC CHIP 0.068MF	10% 25V
JR1601	1-216-295-91	SHORT	0	C5221	1-126-941-11	ELECT 470MF	20% 25V
JR1602	1-216-295-91	SHORT	0	C5223	1-163-021-91	CERAMIC CHIP 0.01MF	10% 50V
	<TRANSISTOR>			C5230	1-104-664-11	ELECT 47MF	20% 10V
Q1603	8-729-026-49	TRANSISTOR 2SA1037AK-T146-R		C5236	1-104-664-11	ELECT 47MF	20% 16V
Q1604	8-729-026-49	TRANSISTOR 2SA1037AK-T146-R		C5240	1-126-964-11	ELECT 10MF	20% 50V
Q1605	8-729-120-28	TRANSISTOR 2SC1623-L5L6		C5257	1-126-960-11	ELECT 1MF	20% 50V
Q1606	8-729-120-28	TRANSISTOR 2SC1623-L5L6		C5258	1-104-664-11	ELECT 47MF	20% 16V
	<RESISTOR>			C5260	1-125-959-11	ELECT CHIP 2200MF	20% 25V
R1603	1-216-673-11	METAL CHIP 8.2K	0.50% 1/10W	C5263	1-125-959-11	ELECT CHIP 2200MF	20% 25V
R1607	1-216-105-91	RES,CHIP 220K	5% 1/10W	C5264	1-163-038-91	CERAMIC CHIP 0.1MF	25V
R1608	1-216-017-91	RES,CHIP 47	5% 1/10W	C5266	1-163-038-91	CERAMIC CHIP 0.1MF	25V
R1609	1-216-065-91	RES,CHIP 4.7K	5% 1/10W	C5275	1-136-165-00	FILM 0.1MF	5% 50V
R1611	1-216-081-00	RES,CHIP 22K	5% 1/10W	C5276	1-136-165-00	FILM 0.1MF	5% 50V
R1614	1-216-089-91	RES,CHIP 47K	5% 1/10W	C5279	1-164-344-11	CERAMIC CHIP 0.068MF	10% 25V
R1615	1-216-089-91	RES,CHIP 47K	5% 1/10W	C5280	1-164-004-11	CERAMIC CHIP 0.1MF	10% 25V
R1620	1-216-073-00	RES,CHIP 10K	5% 1/10W	C5281	1-164-344-11	CERAMIC CHIP 0.068MF	10% 25V
R1621	1-216-671-11	METAL CHIP 6.8K	0.50% 1/10W	C5282	1-164-004-11	CERAMIC CHIP 0.1MF	10% 25V
R1622	1-216-073-00	RES,CHIP 10K	5% 1/10W	C5283	1-126-963-11	ELECT 4.7MF	20% 50V
R1623	1-216-057-00	RES,CHIP 2.2K	5% 1/10W	C5284	1-126-963-11	ELECT 4.7MF	20% 50V
R1624	1-216-057-00	RES,CHIP 2.2K	5% 1/10W	C5285	1-126-964-11	ELECT 10MF	20% 50V
				C5296	1-163-038-91	CERAMIC CHIP 0.1MF	25V
				C5297	1-104-664-11	ELECT 47MF	20% 25V
				C5298	1-126-964-11	ELECT 10MF	20% 50V
				C5303	1-126-963-11	ELECT 4.7MF	20% 50V
				C5304	1-126-963-11	ELECT 4.7MF	20% 50V

The components identified by shading and mark Δ are critical for safety. Replace only with part number specified.

Les composants identifiés par un trame et une marque Δ sont critiques pour la sécurité. Ne les remplacer que par une pièce portant le numéro spécifié.



REF.NO.	PART NO.	DESCRIPTION	REMARK	REF.NO.	PART NO.	DESCRIPTION	REMARK
C5310	1-163-989-11	CERAMIC CHIP 0.033MF	10% 25V			<COIL>	
C5402	1-126-964-11	ELECT 10MF	20% 50V	L5201	1-410-435-21	INDUCTOR 220UH	
C5403	1-126-960-11	ELECT 1MF	20% 50V	L5202	1-410-435-21	INDUCTOR 220UH	
C5405	1-115-339-11	CERAMIC CHIP 0.1MF	10% 50V			<IC LINK>	
C5616	1-126-964-11	ELECT 10MF	20% 50V				
C5620	1-125-960-11	ELECT 4700MF	20% 25V				
		<CONNECTOR>				PS5200 Δ 1-532-984-91LINK, IC (2A/90V AC, 60V DC)	
CN5200*	1-564-506-11	PLUG, CONNECTOR 3P				<TRANSISTOR>	
CN5202*	1-564-508-11	PLUG, CONNECTOR 5P					
CN5204*	1-564-509-11	PLUG, CONNECTOR 6P		Q5001	8-729-422-27	TRANSISTOR 2SD601A-Q	
CN5601*	1-564-508-11	PLUG, CONNECTOR 5P		Q5201	8-729-216-22	TRANSISTOR 2SA1162-G	
CN5605	1-695-915-11	TAB (CONTACT)		Q5202	8-729-216-22	TRANSISTOR 2SA1162-G	
CN5606	1-695-915-11	TAB (CONTACT)		Q5205	8-729-216-22	TRANSISTOR 2SA1162-G	
CN5607	1-695-915-11	TAB (CONTACT)		Q5206	8-729-322-37	TRANSISTOR 2SJ175	
		<DIODE>		Q5207	8-729-422-27	TRANSISTOR 2SD601A-Q	
D5200	8-719-404-49	DIODE MA111		Q5215	8-729-920-21	TRANSISTOR DTC314TK-T-146	
D5201	8-719-404-49	DIODE MA111		Q5216	8-729-920-21	TRANSISTOR DTC314TK-T-146	
D5202	8-719-404-49	DIODE MA111		Q5401	8-729-027-38	TRANSISTOR DTA144EKA-T146	
D5203	8-719-404-49	DIODE MA111		Q5402	8-729-920-21	TRANSISTOR DTC314TK-T-146	
D5204	8-719-404-49	DIODE MA111				<RESISTOR>	
D5205	8-719-510-46	DIODE D1NL20		R5041	1-216-073-00	RES,CHIP 10K	5% 1/10W
D5206	8-719-404-49	DIODE MA111		R5042	1-216-081-00	RES,CHIP 22K	5% 1/10W
D5211	8-719-404-49	DIODE MA111		R5201	1-216-295-91	SHORT 0	
D5212	8-719-404-49	DIODE MA111		R5202	1-240-095-21	RES,CHIP 100K	5% 1/10W
D5401	8-719-977-28	ZENER DIODE DTZ10B		R5203	1-240-095-21	RES,CHIP 100K	5% 1/10W
D5402	8-719-404-49	DIODE MA111		R5204	1-240-095-21	RES,CHIP 100K	5% 1/10W
D5403	8-719-404-49	DIODE MA111		R5205	1-240-095-21	RES,CHIP 100K	5% 1/10W
D5404	8-719-404-49	DIODE MA111		R5206	1-240-099-21	RES,CHIP 220K	5% 1/10W
D5601	8-719-404-49	DIODE MA111		R5207	1-240-103-21	RES,CHIP 470K	5% 1/10W
D5602	8-719-404-49	DIODE MA111		R5208	1-240-099-21	RES,CHIP 220K	5% 1/10W
D5608	8-719-404-49	DIODE MA111		R5209	1-240-103-21	RES,CHIP 470K	5% 1/10W
		<IC>		R5210	1-216-651-11	RES,CHIP 1K	5% 1/10W
IC5200	8-759-273-12	IC TDA7315D013TR		R5211	1-216-651-11	RES,CHIP 1K	5% 1/10W
IC5201	8-759-980-43	IC TDA2009A		R5212	1-216-295-91	SHORT 0	
IC5202	8-759-100-96	IC uPC4558G2		R5214	1-249-377-11	CARBON 0.47	5% 1/4W F
IC5204	8-759-100-96	IC uPC4558G2		R5216	1-216-073-00	RES,CHIP 10K	5% 1/10W
IC5601	8-759-168-19	IC TA78L09F-TE12L		R5217	1-216-025-91	RES,CHIP 100	5% 1/10W
		<JACK>		R5218	1-216-017-91	RES,CHIP 47	5% 1/10W
J5401	1-563-330-11	JACK		R5219	1-240-082-21	RES,CHIP 8.2K	5% 1/10W
		<CHIP CONDUCTOR>		R5222	1-216-025-91	RES,CHIP 100	5% 1/10W
JR5201	1-216-296-91	SHORT 0		R5223	1-240-082-21	RES,CHIP 8.2K	5% 1/10W
		<FERRITE BEAD>		R5225	1-216-081-00	RES,CHIP 22K	5% 1/10W
JW56011	412-911-31	FERRITE 1.1UH		R5229	1-216-651-11	RES,CHIP 1K	5% 1/10W
				R5230	1-216-651-11	RES,CHIP 1K	5% 1/10W
				R5232	1-216-651-11	RES,CHIP 1K	5% 1/10W
				R5233	1-216-651-11	RES,CHIP 1K	5% 1/10W
				R5239	1-216-295-91	SHORT 0	
				R5241	1-240-072-21	RES,CHIP 1.2K	5% 1/10W
				R5246	1-249-389-11	CARBON 4.7	5% 1/4W F
				R5252	1-249-389-11	CARBON 4.7	5% 1/4W F
				R5258	1-216-295-91	SHORT 0	
				R5269	1-216-089-91	RES,CHIP 47K	5% 1/10W

